

















ΤΙΜΟΚΑΤΑΛΟΓΟΣ ΒΑΝΩΝ CHERBROS NORMAL

CherNorm

ΠΙΕΣΗ ΛΕΙΤΟΥΡΓΙΑΣ : ΕΩΣ 50 BAR (1/2")
ΘΕΡΜΟΚΡΑΣΙΑ ΛΕΙΤΟΥΡΓΙΑΣ : 0/+110° C

ΕΙΔΟΣ	ΚΩΔ	ΔΙΑΣΤΑΣΗ	Τιμή	ΕΙΔΟΣ	ΚΩΔ	ΔΙΑΣΤΑΣΗ	Τιμή
 ΜΕ ΧΕΡΟΥΛΙ Θ-Θ NORMAL 	11304	1/2"	6,90	 ΜΕ ΠΕΤΑΛΟΥΔΑ Θ-Θ NORMAL 	11672	1/2"	6,90
	11630	3/4"	10,30		11673	3/4"	10,30
	11663	1"	16,50		11393	1"	16,30
	11664	1 1/4"	25,90		11674	1 1/4"	25,90
 ΜΕ ΧΕΡΟΥΛΙ Α-Θ NORMAL 	11504	1/2"	7,50	 ΜΕ ΠΕΤΑΛΟΥΔΑ Α-Θ NORMAL 	11477	1/2"	7,50
	11654	3/4"	11,20		11670	3/4"	11,20
	11391	1"	17,90		11392	1"	17,90
		1 1/4"	28,90		11671	1 1/4"	28,90
 ΒΑΝΑ ΜΕ ΡΑΚΟΡ NORMAL 	11662	1/2"	11,70	 ΚΑΝΟΥΛΑ ΜΕ ΧΕΡΟΥΛΙ NORMAL 	11191	1/2"	7,80
	03097	3/4"	16,30				
	03092	1"	26,30				
	02831	1 1/4"	41,80				
 ΜΕ ΤΡΕΛΛΟ ΡΑΚΟΡ Α-Θ NORMAL 		1"-3/4	19,50	 ΜΕ ΤΡΕΛΛΟ ΡΑΚΟΡ Θ-Θ NORMAL 	11263	1/2"	11,40
					11264	3/4"	14,30

2ηλό σπείρωμα:
Εξωτερικό αρσενικό 1"
Εσωτερικό θηλυκό 3/4"

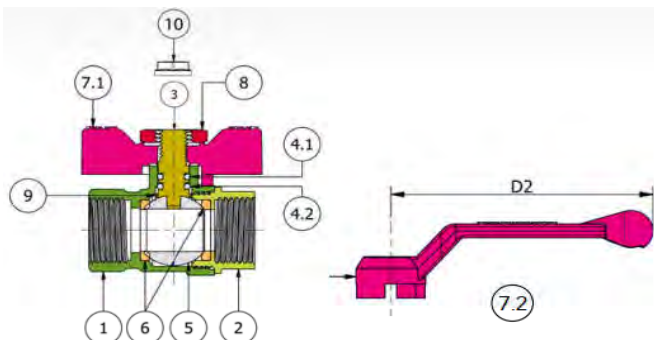

Τεχνικές Προδιαγραφές		
1	ΣΩΜΑ	CW617N UNI EN 12165
2	ΜΑΣΤΟΣ	CW617N UNI EN 12165
3	ΑΞΟΝΑΚΙ	CW614N UNI EN 12164
4.1	O-RING	HNBR 70 GREEN FDA
4.2	O-RING	NBR 70 FDA
5	ΣΦΑΙΡΑ	CW617N UNI EN 12165
6	ΤΕΦΛΟΝ ΣΤΗΡΙΞΗΣ ΜΠΛΙΑΣ	P.T.F.E
7.1	ΛΑΒΗ ΑΛΟΥΜΙΝΙΟΥ ΠΕΤΑΛΟΥΔΑ	EN AB-46100
7.2	ΛΑΒΗ ΑΛΟΥΜΙΝΙΟΥ	EN AB-46100
8	ΠΛΑΞΙΜΑΔΙ	CL04 GEOMET
9	ΤΕΦΛΟΝ ΣΤΕΓΑΝΟΠΟΙΗΣΗΣ	P.T.F.E
10	ΤΑΠΑ	PPS

